

Explorer® Pro
Voyager® Pro

Analytical and Precision Electronic Balances



Explorer® Pro
Voyager® Pro

Analytical and Precision Electronic Balances

Ohaus Explorer® Pro and Voyager® Pro balances, the new standard for performance and value in laboratory balances!

The Ohaus Explorer Pro and Voyager Pro balances were designed for simplicity and include the industry's easiest user interface for effortless setup and operation; no training is required.

Explorer Pro offers all the features and durability found in high-end laboratory balances, while Voyager Pro's Advanced Applications simplify even the most complex laboratory measurements. Plus both balances come with traditional Ohaus quality and support for years of trouble free use!

Standard features include:

- Brilliant backlit high resolution dot matrix display with simple navigation windows and menus to guide you through balance functions
- Five operating languages— English, Spanish, French, German, Italian
- AutoCal™ Automatic Internal Calibration system (standard on Voyager Pro, optional on Explorer Pro)
- User selectable GLP/GMP outputs via RS232 to meet traceability requirements
- EC Type Approved models available
- Weigh-below hook for below-balance weighing applications
- Protective in-use cover and security bracket

For absolute reliability and precision, simplicity in function and operation, exceptional value, and unsurpassed Ohaus support, Explorer Pro and Voyager Pro are the balances of choice

Explorer[®] Pro and Voyager[®] Pro Balances

Analytical Models

Ohaus Explorer *Pro* and Voyager *Pro* feature 4 analytical models with capacities up to 210g and 0.1mg readability for maximum accuracy. The draughtshield design and contoured fit provide optimum draught protection for superior balance stability and reproducibility in challenging environments.



Precision Toploading Models

With 12 precision toploader models and capacities up to 8100g and readabilities to 0.1g, Explorer *Pro* and Voyager *Pro* feature exceptional accuracy. Their rugged design and versatility make these balances ideal for applications in pharmaceutical, chemical, research and quality control and University research.



Explorer *Pro* High Capacity Models

The Explorer *Pro* Series features 3 high capacity precision toploader models with capacities up to 32,000g and readabilities to 0.1g. The extra large 28 x 35.6 cm platform is ideal for laboratory and industrial applications in concrete/asphalt production, agriculture and quality control. Explorer High Capacity includes Check and Differential Weighing, Statistical Functions, Formulation, and Filling.



Application Modes

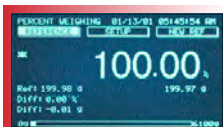

Percentage Weighing

Percentage weighing allows you to place a reference load on the pan, and check other samples as a percentage of the reference load. Each new sample will be a "percentage" of the original reference, the display shows the variance in – or + percent of the reference.

display shows the variance in – or + percent of the reference.

Weighing

Basic weighing with primary and secondary weighing units, time, date and capacity bar.



Gross/Net/Tare

G/N/T is an application mode commonly used when you need to identify the individual weights of the container, the material and both together.



Dynamic Weighing

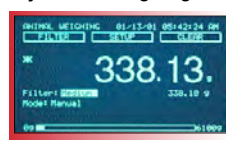

This mode can be set to manual, semi-automatic, or automatic.

Dynamic weighing allows the user to weigh unstable matter that may be

Parts Counting

Enhanced parts counting features include auto sample optimization, user definable sample size and manual entry using scroll keys. The "Parts Counting Check" feature allows for quickly checking a sample of pieces against a preset criteria, with results displayed as the number of pieces. The "Parts Counting Fill" feature allows for quickly checking a sample of pieces against an established criteria, with results displayed as a percentage of the preset target.



Checkweighing

Checkweighing is used when items need to be checked against a present target, using over/under parameters. The display automatically shows the difference in percent and weight.

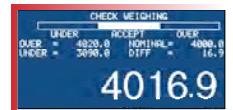

Analytical and Precision Balances

Ohaus Explorer *Pro* and Voyager *Pro* balances were designed with the user in mind. They feature an ultra-simple and innovative user interface with on screen text prompts and scroll down menus. One-step operation guides you through the application modes with a single button press. The state of the art high-resolution display is easy to view and displays only the information you want to see. Explorer *Pro* and Voyager *Pro* balances were designed with a spill channel and include an in-use cover. These balances are manufactured to ISO 9001 quality assurance specifications, for traditional Ohaus quality you've come to expect.

Key Features

Superior Draughtshield

A large 3-door draughtshield is standard on all Analytical and Precision balances with a 0.1/1mg readability. The draughtshield design provides optimum draught protection from wind currents for superior balance stability and reproducibility even in challenging environments. The large chamber can accommodate larger vessels and the removable side doors make it easy to clean.

Automatic Calibration

The AutoCal™ calibration feature automatically calibrates the balance when it senses a temperature change sufficient enough to affect weighing accuracy. This assures accuracy while saving operational time. This feature is standard on Voyager *Pro* models and available as an option on Explorer *Pro*.

Multi-Language Text

Explorer *Pro* and Voyager *Pro* balances offer 5 language operational display text. Standard language text includes: English, Spanish, French, Italian and German.

Large Brilliant Display

A high-resolution dot matrix display with backlight provides enhanced viewing in any environment. The large display screen features user definable text fields to illustrate only the information you want! The display also shows secondary units, time and date. Text prompts simplify menu navigation and balance setup. Display features adjustable contrast and brightness controls.

Protective Cover

Explorer *Pro* and Voyager *Pro* balances feature a durable in-use cover as standard equipment. The replaceable cover protects the display from harsh environments or spills that can ruin the balance.

Communications Port with GLP/GMP Data Output

The standard RS232 communication port offers connectivity and it's GLP/GMP data output capability prints time, date, balance, project, user ID, calibration information and weighing information. Simply connect your Voyager *Pro* to the optional Ohaus SF42 accessory printer and full traceability of weight readings is achieved without the need for sophisticated, expensive peripherals.

Levelling Feet for Quick Set-Up

Standard on all models, the front level bubble assures accurate operation.

Innovative Software

Simple to use and easy to follow, with no training or manual required! The 3 application-specific soft-keys allow direct access to features such as calibration, units, sample size and reference information at a touch of a button.

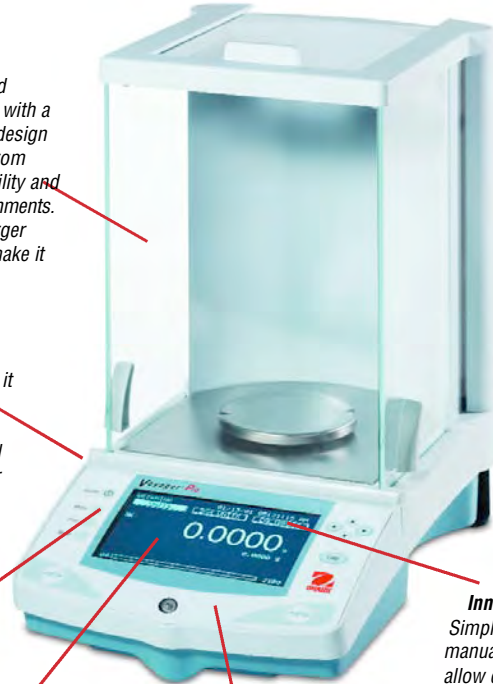

Explorer *Pro* and Voyager *Pro*: Weighing Units for Every Application.

For total versatility, Explorer *Pro* offers 7 application modes and 16 standard weighing units for almost any type of mass measurement application. Voyager *Pro* adds 6 additional application modes!

Weighing Modes Include

- Milligrams
- Grams
- Kilograms*
- Pounds*
- Ounces
- Carats
- Troy Ounces
- Newtons
- Grains
- Mommes
- Tals (3)
- Ticals
- Pennyweights
- User Programmable Custom Unit

*not available on Analytical units

Explorer *Pro* Application Modes:

- Weighing
- Parts Counting
- Dynamic Weighing
- Percentage Weighing
- Checkweighing
- Filling
- Gross/Net/Tare Weighing

Voyager *Pro* Adds These Additional Application Modes:

- Differential Weighing
- Formulation
- Statistics
- Density Determination
- SQC
- Pipette Calibration

Explorer® Pro and Voyager® Pro Balances

General Specifications

Weighing Units	gram, milligram, ounce, ounce troy, carat, pennyweight, Hong Kong Tael, Singapore Tael, Taiwan Tael, mommes, grain, tical, Newton, custom
Application Modes - Explorer Pro	Weighing, Parts Counting, Dynamic Weighing, Checkweighing, Percent Weighing, Filling, Gross/Net/Tare Weighing
Application Modes - Voyager Pro	Statistics, Formulation, Differential Weighing, SQC, Density Determination, Pipette Calibration, Parts Counting, Dynamic Weighing, Checkweighing, Percent Weighing, Filling, Gross-Net-Tare Weighing
Features	Applications Library, RS232 Port, Auxiliary Display Port, GLP Protocol, Selectable Operating Language, Selectable Displayed Information Settings, Selectable Environmental Settings, Selectable Auto-Print Settings, Integral Weigh Below Hook, Contrast & Brightness Control, Protective In-Use Cover
Tare range	Full Capacity by Subtraction
Operating Temperature Range	10° to 30° C without AutoCal™ 10° to 40°C with AutoCal™
Power Requirements	100-120 V AC, 220-240 V AC, 50/60 Hz
Calibration	Internal / External
Display Type	LCD Dot Matrix w/Backlight
Display Size (cm)	240 x 128 pixels

Precision Balances

Capacity (g)	210	410	610	100 / 410	610	2100	4100	6100	1000 / 4100	4100	6100	8100	
Readability (g)	0.001		0.001/0.01		0.01			0.01/0.1		0.1			
Repeatability (Std. dev.) (g)	0.0005		0.0015		0.0005/0.005		0.005		0.01		0.01/0.05		0.05
Linearity (g)	± 0.002		± 0.002/0.005		± 0.02		± 0.04		± 0.02/0.05		± 0.1		
Stabilization Time (seconds)	3												
Pan Size (cm)	12 dia.				17.2 x 17.2 with Windshield					20.3 x 20.3 [§]			
Dimensions WxHxD (cm)	21 x 35 x 35				21 x 10.3 x 35								
Net Weight (kg)	6				5								
Explorer Pro w/o AutoCal™	EP213	EP413	EP613	EP413D*	EP612	EP2102	EP4102	EP6102	EP4102D*	EP4101	EP6101	EP8101	
Explorer Pro w/ AutoCal™	EP213C	EP413C	EP613C	EP413DC*	EP612C	EP2102C	EP4102C	EP6102C	EP4102DC*	EP4101C [§]	EP6101C [§]	EP8101C [§]	
Voyager Pro	VP213C	VP413C	VP613C	VP413DC*	VP612C	VP2102C	VP4102C	VP6102C	VP4102DC*	VP4101C	VP6101C	VP8101C	

* Moveable FineRange™

§ Balances with AutoCal™ are equipped with a 17.2 cm x 17.2 cm pan and windshield.

Analytical Balances

Capacity (g)	62	110	210	100 / 210
Readability	0.1 (mg)			0.1 / 1 (mg)
Repeatability (Std. dev.)	0.1 (mg)			0.1 / 0.5 (mg)
Linearity	± 0.2 (mg)			± 0.2 / 0.5 (mg)
Stabilization Time (s)	4			
Pan size (cm)	9			
Dimensions WxHxD (cm)	21 x 35 x 35			
Net Weight (kg)	6			
Explorer Pro w/o AutoCal™	EP64	EP114	EP214	EP214D*
Explorer Pro w/ AutoCal™	EP64C	EP114C	EP214C	EP214DC*
Voyager Pro	VP64C	VP114C	VP214C	VP214DC*

* Moveable FineRange™

§ Balances with AutoCal™ are equipped with a 17.2 cm x 17.2 cm pan and windshield
AutoCal models are available as EC Type Approved versions (exceptions: EP613C and VP613C)

High Capacity Balances

	12000	22000	32000
Readability	0.1 (g)		
Repeatability (Std. dev.)	0.1 (g)		
Linearity	± 0.4 (g)		
Stabilization Time (s)	4		
Pan size (cm)	28 x 35.6		
Dimensions WxHxD (cm)	36 x 14 x 44.5		
Net Weight (kg)	12.3		
EP12001[†]	EP22001[†]	EP32001[†]	
EP12001C[†]	EP22001C[†]	EP32001C[†]	
n/a	n/a	n/a	

Voyager[®] Pro Applications

Statistical Quality Control (SQC)

The SQC feature is extremely useful when it is desired to monitor and control a process to eliminate under and over filling. Provisions are made in the balance to accommodate the weight of various packaging processes. During operation, parameters of the packaged product are set into the balance including packaging weight, acceptable weight limits and non-acceptable weight limits of the product.



These weight limits are identified as +T1, +T2, NOMINAL and -T1, -T2. As samples are weighed and stored in the balance, a trend analysis is developed and displayed on the balance. Each batch of samples is shown on the display which indicates the maximum/minimum standard deviation and mean values for each batch. An on going examination of the relative deviation of the samples can be viewed and is stored, allowing you to effectively monitor the filling process operation.

Statistics

Batch	Sample	11/17/03	01:26:24 PM
Total	Batches	3	
Total	Containers	30	
Mean		0.0570	
Max		0.0664	
Min		0.0483	
Std. Dev		0.0066	
+T1		0.0570	
+T2		0.0664	
-T1		0.0483	
-T2		0.0483	
Last	Sample	11/17/03	01:31:20 PM

Statistics are used when it is desired to compare a number of samples and examine the relative deviation of the samples along with other statistical data.

A minimum of three samples are required in this program. Statistics options include: number of samples, maximum, minimum, difference, sum, mean, standard deviation, relative deviation, auto sample, and auto print. Weighing, Dynamic Weighing, Checkweighing and Filling application modes can also be linked to the Statistics mode to provide statistical data.

Differential Weighing

Differential weighing stores tare and weight values so samples can be dried or processed and the difference in weight be calculated. Up to 80 samples can be stored.

The balance has the capability to work with one or two different containers or no container at all.

Sample #	Total WT	Final WT	WT Diff
1	10.9905	9.9902	-0.9903
2	10.9901	9.9902	-0.9979
3	10.9902	9.9902	-0.9998
4	10.9904	9.9903	-0.9981
5	10.9902	9.9902	-0.9988
6	10.9904	9.9902	-0.9982
7	10.9903	9.9902	-0.9981
8	10.9903	9.9902	-0.9981
9	10.9909	9.9907	-0.9982

Pipette Calibration

Pipette calibration checks the accuracy and precision values of pipettes by weight analysis. An analytical balance is recommended for maximum accuracy. The balance is capable of recording data from 3 to 30 samples of each pipette tested. The density table for water is included and if liquid is used for pipette calibration, Voyager Pro will accept the alternate liquid's density in g/cc at current room temperature.

PIPETTE	11/17/03	03:56:21	Statist Fail
Nominal	500.000L	Inaccuracy	1.52 %
95.5	25	Imprecision	0.32 %
494.0	σ	+	
492.4	R	+	
490.8	σ	+	
489.2	σ	+	

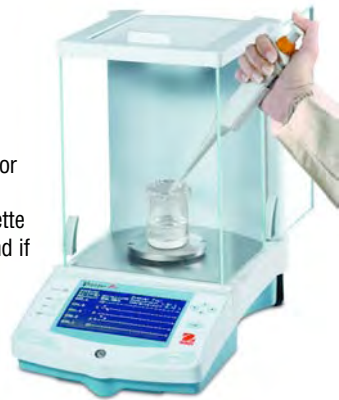

Density

An accessory density determination kit is designed to be used with Ohaus Voyager Pro balances. A built-in reference density table for water at temperatures between 10°C and 30°C is included in the balance software.



DENSITY	11/18/03	03:04:38 PM	
TEMP	25.00	DENSITY	
WT	12.5583	g/cc	
Time	25.0	Temp	7.0000
Max	01:0.9971	Lim	7.2433
		Un	0.63 cc

Formulation

Formulations can be named and have from 2 to 10 components specified. Once named, they may be recalled and used at any time. Each component of a given formulation can be

ITEM	Target	Result	Diff
ITEM 1	20.0000	19.9749	-0.0251
ITEM 2	35.0000	35.0400	0.0400
ITEM 3	40.0000	39.9865	-0.0135
Total	95.0000	95.0022	0.0022

specified as to its weight or percentage. Each element of a formulation is shown on a dual bar graph as a percentage and displays the desired weight. Thus, each component may be placed on the pan until 100% is indicated.

Explorer® Pro and Voyager® Pro Balances

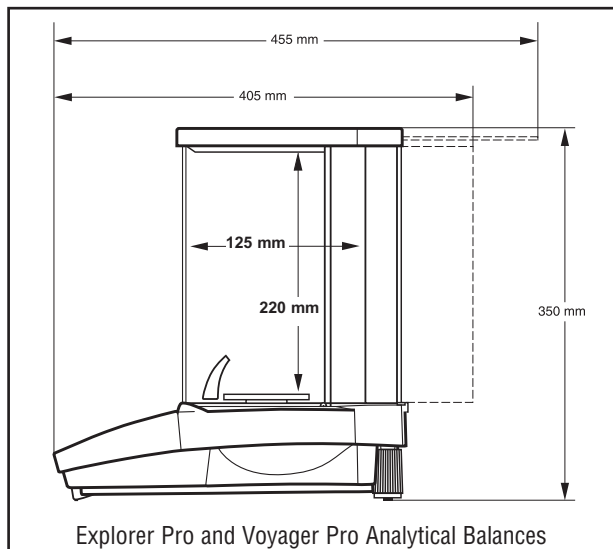

Explorer Pro and Voyager Pro Analytical Balances

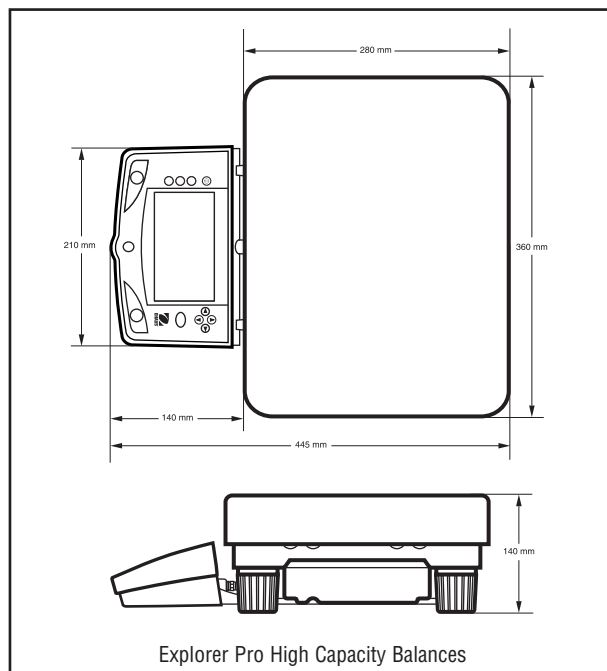

Explorer Pro High Capacity Balances

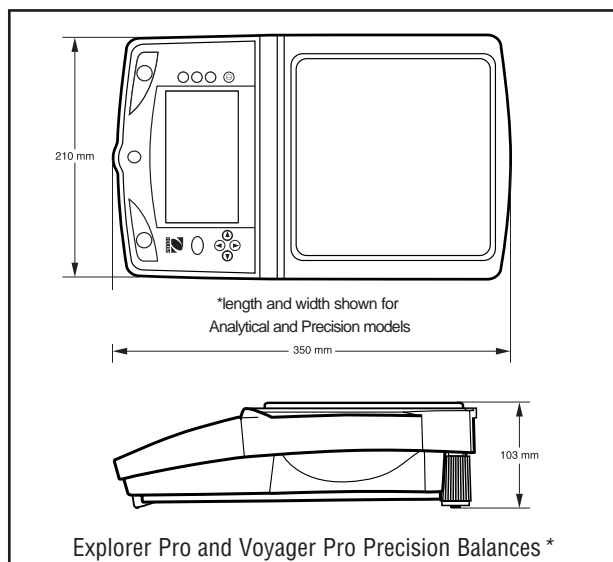

Explorer Pro and Voyager Pro Precision Balances *

Additional Features

RS232 port for easy communication with computer or printer, GLP compliant with user selectable outputs, protective in-use cover, security bracket

Optional Accessories

Explorer *Pro* and Voyager *Pro* balances offer a complete line of accessories and masses to expand your mass measurement capabilities, including: Density determination kit (for 0.1mg and 1mg balances), model SF42 42-column impact printer, security devices, RS232 cables, calibration masses. Contact your Ohaus dealer for our complete offering.

Industry Leading Quality and Support

All Ohaus Explorer® *Pro* Voyager® *Pro* balances are manufactured under an ISO 9001:2000 Registered Quality Management System. Our rugged construction and stringent quality control have been hallmarks of all Ohaus products for nearly a century.

Ohaus UK Ltd.

64 Boston Road
Beaumont Leys
Leicester LE4 1AW
Tel.: 0116 234 5075
Fax: 0116 235 9256
e-mail: uksales@ohaus.com

Ohaus Europe GmbH

Im Langacher
CH-8606 Greifensee
Switzerland
Tel.: +41-44-944 33 66
Fax: +41-44-944 32 30
e-mail: EuropeSales@Ohaus.com

Ohaus Corporation

* 19 Chapin Road
Pine Brook, NJ 07058 USA
Tel.: +1-973-377-9000
Fax: +1-973-593-0359
e-mail: OhausHQ@Ohaus.com

With offices in Mexico, Switzerland, England, Germany, France, Spain, Italy, Poland, Russia, Japan, Korea and China

* ISO 9001

Registered Quality Management System

www.ohaus.com

80774197 07.2005 © Copyright Ohaus Corporation

