

# *FX-i* *FX-iWP* Series



**AND** ...Clearly a Better Value  
A&D Company, Limited  
<http://www.aandd.jp>

# Realizing Compact, Increasing Functions!

We have developed a Miniaturized SHS\* (Super Hybrid Sensor) to achieve a highly compact precision balance, which is 40% lighter and 47% smaller than our GF series with a 25% smaller footprint, while maintaining A&D's superior weighing functions. \*Patent Pending



**FX-120i**  
122gx1mg

**FX-200i**  
220gx1mg

**FX-300i**  
320gx1mg

**FX-1200i**  
1220gx10mg

**FX-2000i**  
2200gx10mg

**FX-3000i**  
3200gx10mg

# FX-i



## Response Indicator Function

Selectable FAST, MID or SLOW response to suit weighing environment conditions

## Comparator Function

Easy to compare weighing results by setting HI limit and LO limit to display HI,OK,LO indicator

## ACAI – Automatic Counting Accuracy Improvement

This counting function recalculates the average unit weight each time a sample is added to eliminate errors caused by variations in unit weight

## Percent Mode Function

A sample can be registered as 100% and the weight of another sample can be compared as a percentage

## ***B5 Size Footprint***

Ideal for installation and use in narrow spaces

## ***Compact SHS–1 Second Stabilization***

Quick stabilization speed with accurate weighing for better productivity

## ***Shock Absorber Function\****

The internal shock absorber protects the SHS from the adverse effects of vertical or transverse overloading. \*Patent Pending

## ***Quick USB Interface (FXi-02)***

Easy-to-use optional USB interface, **with no driver installation necessary**, for transfer of weighing data to a computer (applicable OS – Windows 98 OSR2 or later)

## ***SCF–Statistical Calculation Function***

Can display and/or output statistical calculation data as No. (number of data), SUM (total), MAX (maximum), MIN (minimum), R [range (maximum – minimum)], AVE (average), SD (standard deviation) and CV (coefficient of variation)

## ***LAN–Ethernet Interface (FXi-08) with WinCT-Plus Software***

WinCT-Plus software makes it possible for the user to easily set up an IP address, subnet mask etc. The user can also send commands for control and acquisition of data from multiple FX-i balances.

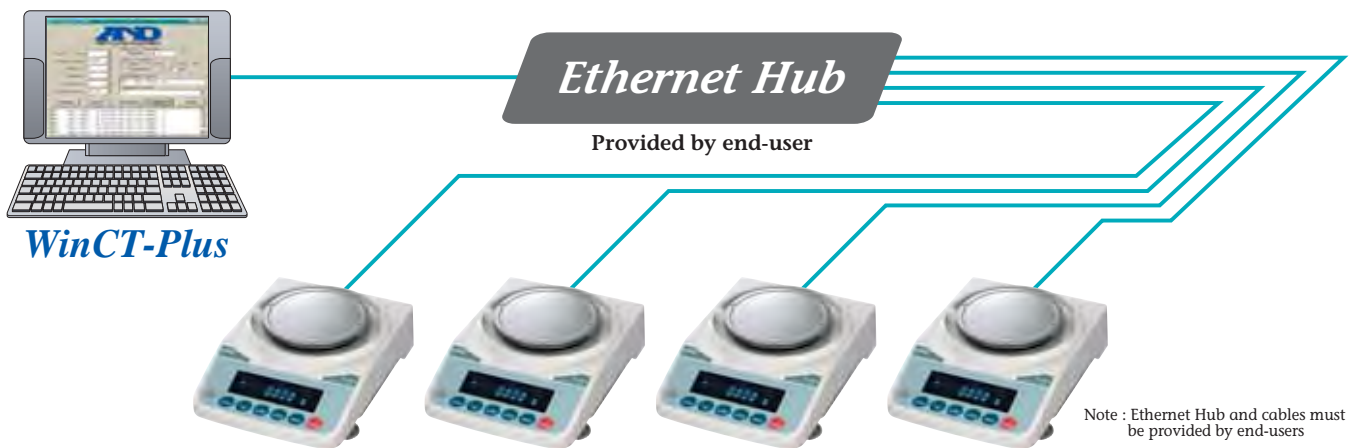

### **Animal Weighing Function**

The HOLD function enables freezing of weighing data for animal weighing applications and an ANIMAL indicator appears on the display

### **Standard RS-232C Interface**

Incorporates bi-directional communication with a PC, printer or other peripheral devices

### **Underhook**

The underhook, for hanging applications, allows for measurement of magnetic materials and density measurements in air and water

### **Multiple Weighing Units of Measurement**

Programmable or standard weighing units of measurement can be selected; g, pcs, %, oz, lb, L oz, ozt, ct, mom, dwt, GN, tl, tol, mes and MLT

# The World's First IP65 Compliant, Water / Dust Proof Precision (1mg) Balance!

Yet another breakthrough from A&D enabling the measurement of liquid or powder at 1mg resolution, eliminating any worries about damage to the balance



**FX-120iWP**  
122gx1mg

**FX-200iWP**  
220gx1mg

**FX-300iWP**  
320gx1mg

**FX-1200iWP**  
1220gx10mg

**FX-2000iWP**  
2200gx10mg

**FX-3000iWP**  
3200gx10mg

# FX-iWP

**SHS**  
Super Hybrid Sensor

**888**  
VFD Display

**44A**  
Anti-static Counting  
Accuracy Approximation

**GLP**

**RS-232C**

**FDC**  
Full Digital Calibration

**COMPARATOR**

**ON**

**OFF**

**Buzzer Function**

**ID**

**LAN**

**ANIMAL**

**USB**

**under hook**

**SCF**

**IP65**  
Standard Calibration Function

## GLP/GMP/GCP/ISO Compliant

In accordance with GLP and LIMS regulations, the balance ID number and calibration data can be printed out using A&D's AD-8121B or a PC

## Auto Power ON Function

The weighing mode display activates automatically with AC power so there is no need to press the ON/OFF key

## Auto Power OFF Function

The display switches OFF automatically when the balance is inactive for 10 minutes as a power-saving tool

## Built-in Rechargeable Battery (FXi-09)\*

An optional Ni-MH rechargeable battery pack can be fitted into the FX-i series for use without AC power and for mobile applications (10 hours charging time for 8 hours operation)

\* Not IP65 compliant when used with FX-iWP



*IP65 means that this kind of measurement is possible.*



*Highly Visible Display*



*Firmly Sealed Pan Support*



*Water Proof RS-232C Cable (optional)*



*Large Breeze Break (optional)*

The small breeze break comes as standard with the FX-120i(WP), FX-200i(WP) and FX-300i(WP), which are all 1mg resolution models.

## Specifications

|  | FX-120i<br>FX-120iWP  | FX-200i<br>FX-200iWP                                   | FX-300i<br>FX-300iWP | FX-1200i<br>FX-1200iWP | FX-2000i<br>FX-2000iWP | FX-3000i<br>FX-3000iWP  |
|--|---|--|----------------------|------------------------|------------------------|-------------------------|
| Weighing capacity                          | 122g  | 220g   | 320g                 | 1220g                  | 2200g                  | 3200g                   |
| Minimum weighing value                     |   | 0.001g   |                      |                        | 0.01g                  |                         |
| Counting mode                              | Minimum unit mass   | 0.001g   |                      |                        | 0.01g                  |                         |
|  | Number of samples   | 5, 10, 25, 50 or 100 pieces                            |                      |                        |                        |                         |
| Percent mode                               | Minimum 100% reference mass   | 0.001g   |                      |                        | 1.00g                  |                         |
|  | Minimum 100% display  | 0.01%, 0.1%, 1% (depends on the reference mass stored) |                      |                        |                        |                         |
| Repeatability (Standard Deviation)         |   | 0.001g   |                      |                        | 0.01g                  |                         |
| Linearity                                  |   | ±0.002g  |                      | ±0.02g                 |                        |                         |
| Stabilization time (typically set at FAST) | Approx. 1 second  |  |                      |                        |                        |                         |
| Sensitivity drift (10°C to 30°C)           | ±2ppm / °C  |  |                      |                        |                        |                         |
| Operating temperature                      | 5°C to 40°C (41°F to 104°F), 85%RH or less (no condensation)                        |  |                      |                        |                        |                         |
| Display type                               | Vacuum Fluorescent Display (VFD)  |  |                      |                        |                        |                         |
| Display refresh rate                       | 5 times /second, 10 times /second or 20 times /second                               |  |                      |                        |                        |                         |
| Standard serial interface                  | RS-232C Interface   |  |                      |                        |                        |                         |
| Weighing pan (diameter)                    | 130mm   |  |                      | 150mm                  |                        |                         |
| External calibration mass                  | 100g<br>50g   | 200g<br>100g   | 300g<br>200g<br>100g | 1000g<br>500g          | 2000g<br>1000g         | 3000g<br>2000g<br>1000g |
| AC adaptor                                 | Confirm that the adaptor type is correct for the local voltage and power receptacle |  |                      |                        |                        |                         |
| Power consumption                          | Approx. 11VA (supplied to the AC adaptor)   |  |                      |                        |                        |                         |
| External dimensions                        | 193 (W) X 262.5 (D) X 85.5 (H) mm   |  |                      |                        |                        |                         |
| Net weight                                 | FX-i Approx. 2.5kg / FX-iWP Approx. 2.7kg   |  |                      |                        |                        |                         |

## Options

- FXi-02\*** Quick USB interface with cable
- FXi-08\*** Ethernet interface with WinCT-Plus software
- FXi-09\*** Built-in rechargeable battery
- FXi-10** Small breeze break
- FXi-11** Large breeze break
- FXi-WP-10** Small breeze break (gray)
- FXi-WP-11** Large breeze break (gray)
- FXi-12** Animal weighing pan
- FXi-15** Carrying case

\* FXi-02, FXi-08 and FXi-09 cannot be used at the same time.  
(Not IP65 compliant when used with FX-iWP)

## Accessories

- AD-1683** Static eliminator
- AD-8920\*** Remote display
- AD-8922\*** Remote controller
- AD-8121B\*** Compact printer
- AD-8526\*** RS/Ethernet converter
- AX-CARATPAN** Carat pan
- AX-KO2737-500-EX** Waterproof RS-232C cable (5m)

\* (Not IP65 compliant when used with FX-iWP)



AD-8121B

## External Dimensions (mm/inches)

### Pan size

| Model                                | A          |
|--------------------------------------|------------|
| FX-120i(WP) / 200i(WP) / 300i(WP)    | 130 / 5.12 |
| FX-1200i(WP) / 2000i(WP) / 3000i(WP) | 150 / 5.91 |

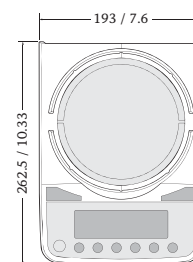
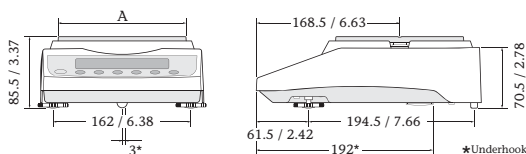

### Dimensions with Small Breeze Break (FXi-10/FXi-WP-10) (Comes equipped with FX-120i(WP)/200i(WP)/300i(WP))

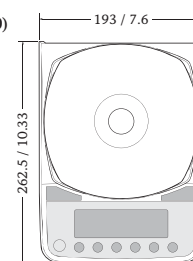
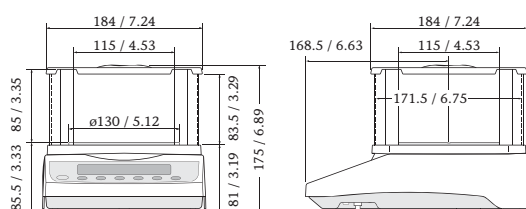

### Dimensions with Large Breeze Break (FXi-11/FXi-WP-11)

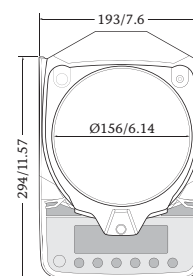
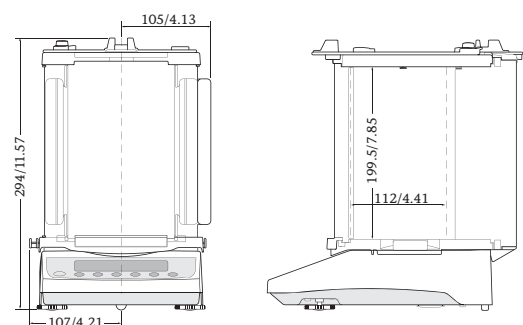

# AND

...Clearly a Better Value

### A&D Company, Limited

3-23-14 Higashi-Ikebukuro, Toshima-ku, Tokyo 170-0013 JAPAN  
Telephone:[81](3) 5391-6132 Fax:[81](3) 5391-6148  
http://www.aandd.jp

### A&D ENGINEERING, INC.

1756 Automation Parkway, San Jose, CA 95131 U.S.A.  
Telephone:[1](408) 263-5333 Fax:[1](408) 263-0119

### A&D MERCURY PTY. LTD.

32 Dew Street, Thebarton, South Australia 5031 AUSTRALIA  
Telephone:[61](8) 8301-8100 Fax:[61](8) 8352-7409

### A&D INSTRUMENTS LTD.

Unit 24/26 Blacklands Way Abingdon Business Park,  
Abingdon, Oxon OX14 1DY UNITED KINGDOM  
Telephone:[44](1235) 550420 Fax:[44](1235) 550485

### <German Sales Office>

Große Straße 13 b 22926 Ahrensburg GERMANY  
Telephone:[49](0) 4102 459230 Fax:[49](0) 4102 459231

### A&D KOREA Limited

Manhattan Bldg. 8F, 36-2 Yoido-dong, Youngdeungpo-gu, Seoul, KOREA  
Telephone:[82](2) 780-4101 Fax:[82](2) 782-4280

### A&D RUS CO., LTD.

Vereyskaya str.112 Kuntsevo Block, 121357,  
Moscow, Russia  
Telephone: [7] (495) 937-33-44 Fax: [7] (495) 937-55-66